

MPRI

Abstract interpretation of protein-protein interactions networks

Jérôme Feret

DI - ÉNS



Tuesday, the 30th of October, 2018

Joint-work with...



Walter Fontana
Harvard Medical School



Vincent Danos
ÉNS



Ferdinanda Camporesi
Bologna / ÉNS

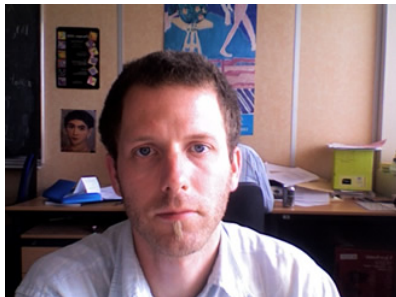

Russ Harmer
ÉNS Lyon



Jean Krivine
Paris VII

Signalling Pathways

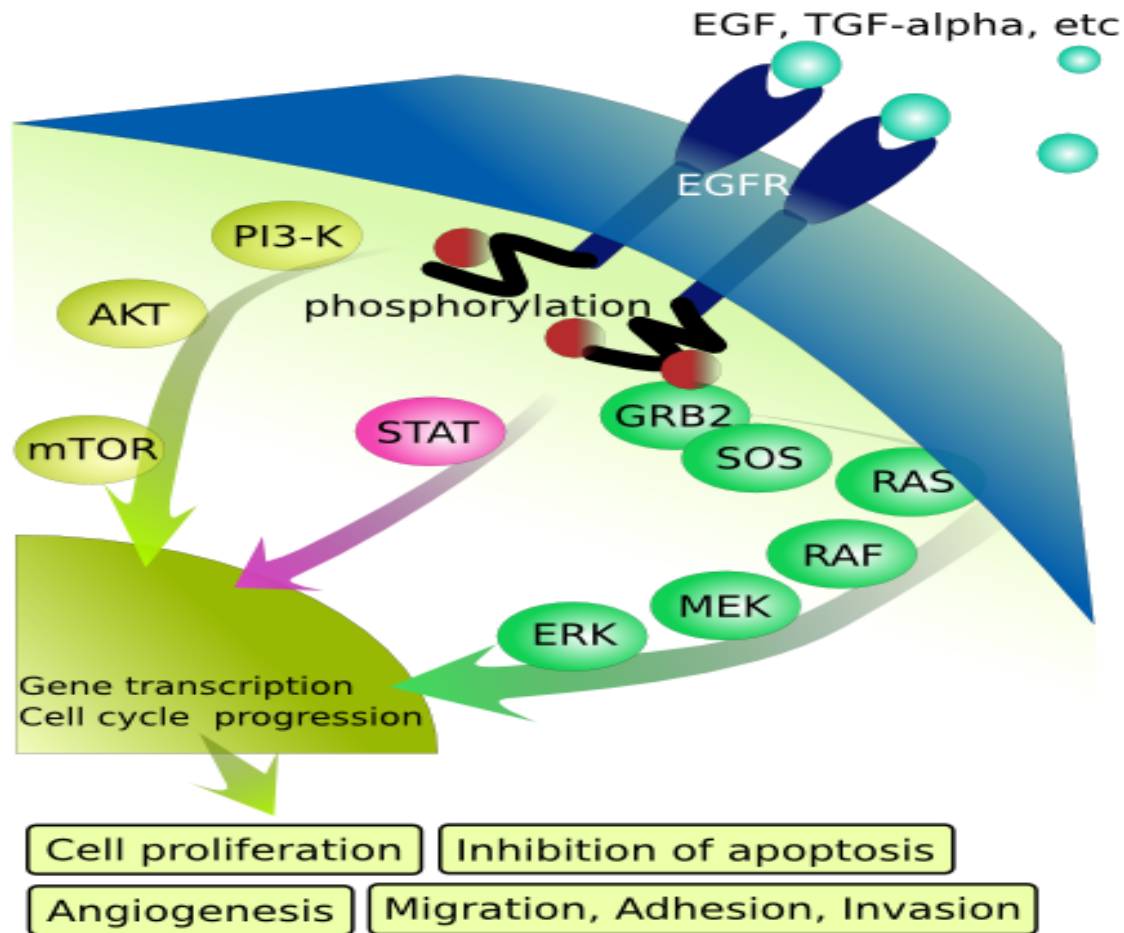

Eikuch, 2007

Bridging the gap between...

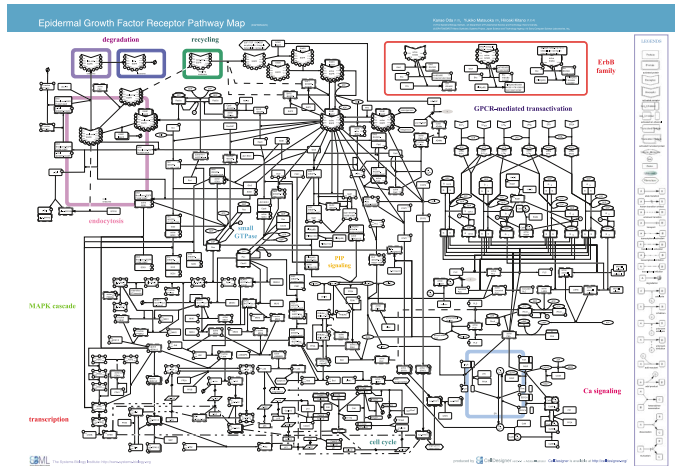

$$\begin{cases} \frac{dx_1}{dt} = -k_1 \cdot x_1 \cdot x_2 + k_{-1} \cdot x_3 \\ \frac{dx_2}{dt} = -k_1 \cdot x_1 \cdot x_2 + k_{-1} \cdot x_3 \\ \frac{dx_3}{dt} = k_1 \cdot x_1 \cdot x_2 - k_{-1} \cdot x_3 + 2 \cdot k_2 \cdot x_3 \cdot x_3 - k_{-2} \cdot x_4 \\ \frac{dx_4}{dt} = k_2 \cdot x_3^2 - k_2 \cdot x_4 + \frac{v_4 \cdot x_5}{p_4 + x_5} - k_3 \cdot x_4 - k_{-3} \cdot x_5 \\ \frac{dx_5}{dt} = \dots \\ \vdots \\ \frac{dx_n}{dt} = -k_1 \cdot x_1 \cdot c_2 + k_{-1} \cdot x_3 \end{cases}$$

knowledge
representation

and

models of the
behaviour of
systems

Site-graphs rewriting

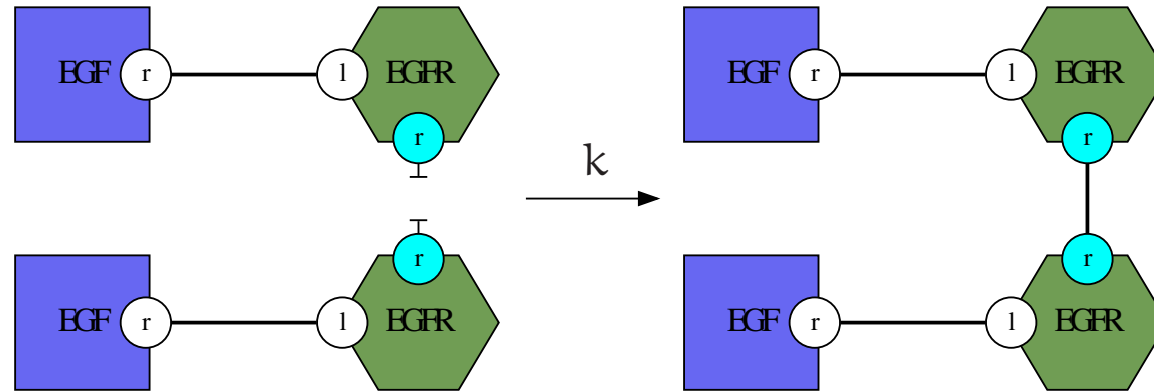

- a language close to knowledge representation;
- rules are easy to update;
- a compact description of models.

Choices of semantics

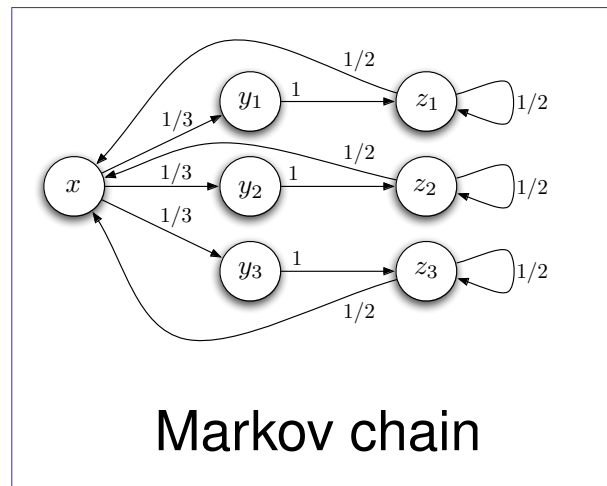
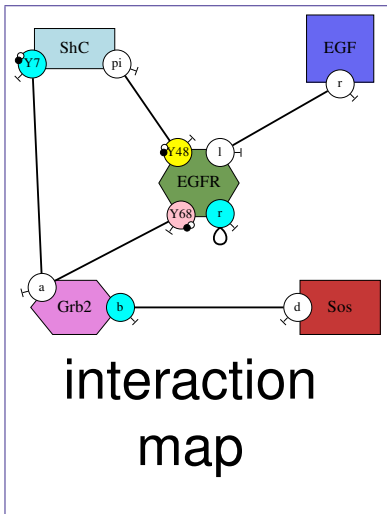
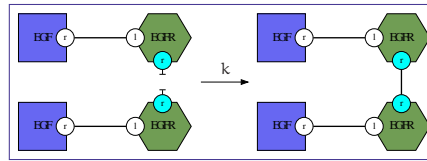

$$\begin{cases} \frac{dx_1}{dt} = -k_1 \cdot x_1 \cdot x_2 + k_{-1} \cdot x_3 \\ \frac{dx_2}{dt} = -k_1 \cdot x_1 \cdot x_2 + k_{-1} \cdot x_3 \\ \frac{dx_3}{dt} = k_1 \cdot x_1 \cdot x_2 - k_{-1} \cdot x_3 + 2 \cdot k_2 \cdot x_3 \cdot x_3 - k_{-2} \cdot x_4 \\ \frac{dx_4}{dt} = k_2 \cdot x_3^2 - k_2 \cdot x_4 + \frac{v_4 \cdot x_5}{p_4 + x_5} - k_3 \cdot x_4 - k_{-3} \cdot x_5 \\ \frac{dx_5}{dt} = \dots \\ \vdots \\ \frac{dx_n}{dt} = -k_1 \cdot x_1 \cdot c_2 + k_{-1} \cdot x_3 \end{cases}$$

ordinary differential equations

Complexity walls

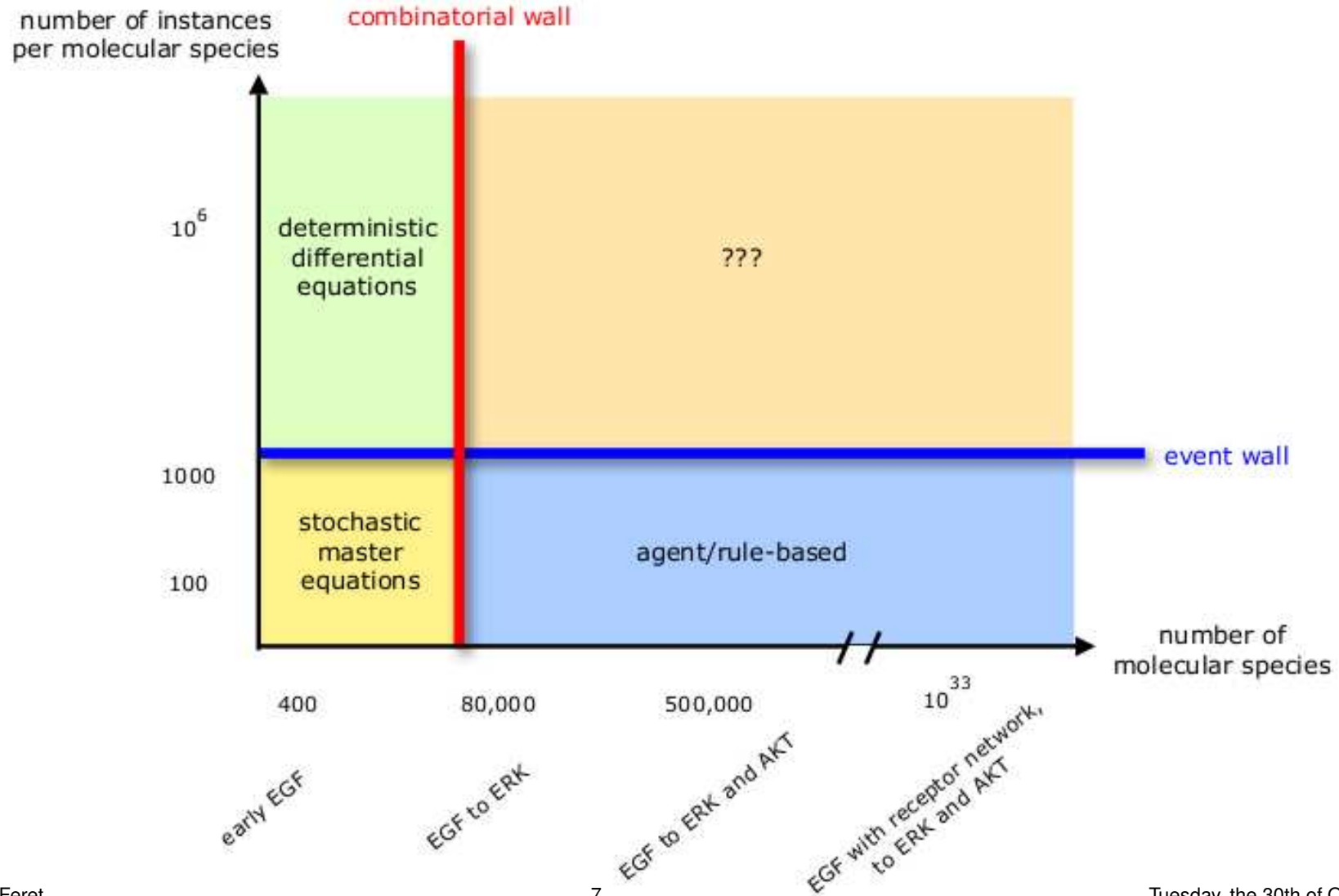

Abstractions offer different perspectives on models

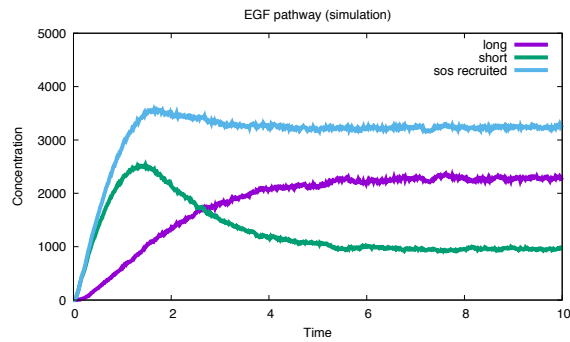

concrete semantics

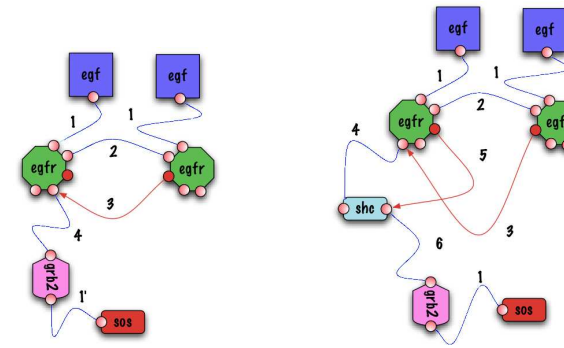

causal traces

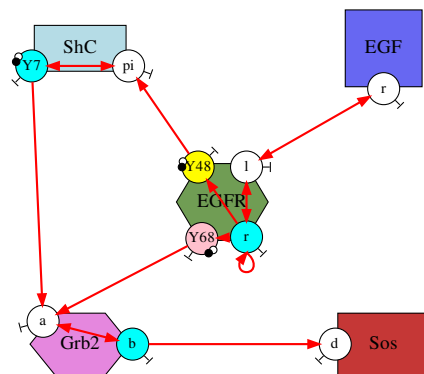

information flow

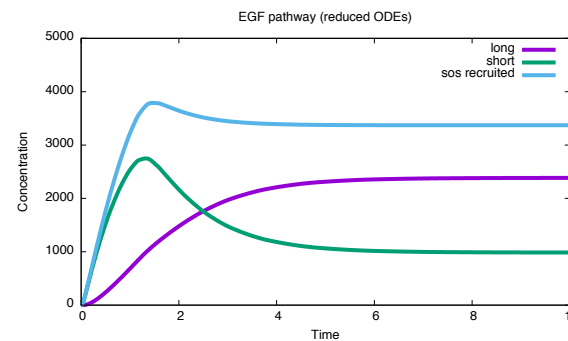

exact projection of the ODE semantics

Static analysis of reachable species (I/II)

We capture the relationships between the states of the sites of each agent.

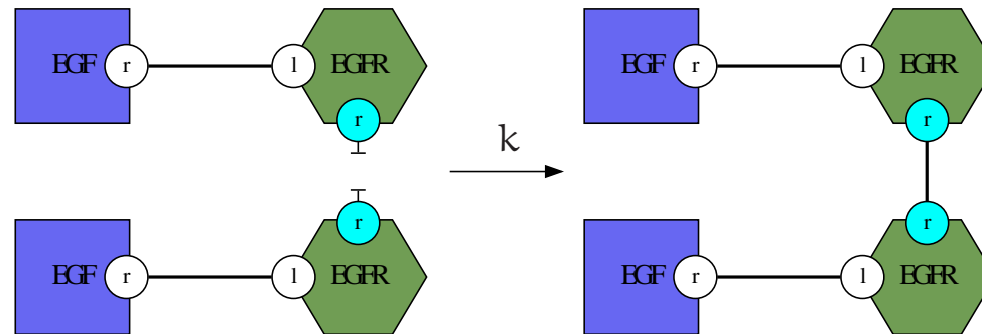

Static analysis of reachable species (I/II)

We capture the relationships between the states of the sites of each agent.

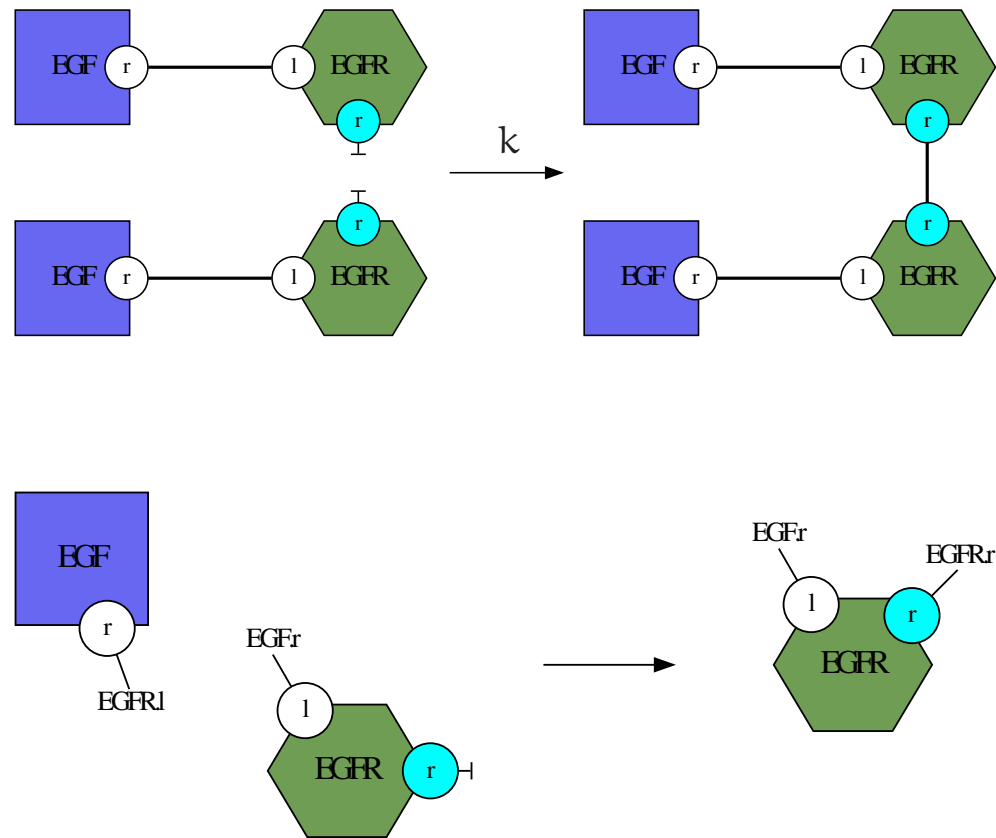

Static analysis of reachable species (II/II)

Applications:

1. check the consistency of a model [ICCMSE'07]
2. compute the properties to allow fast simulation [APLAS'07]
3. simplify models,
4. compute independent fragments of chemical species [PNAS'09, LICS'10, Chaos'10]

The analysis is complete (no false positif) for a significant kernel of Kappa [VMCAI'08].

Model reduction

The ground differential system uses one variable per chemical species;
We directly compute its exact projection over independent fragments of chemical species.

With a small model, 356 chemical species are reduced into 38 fragments:

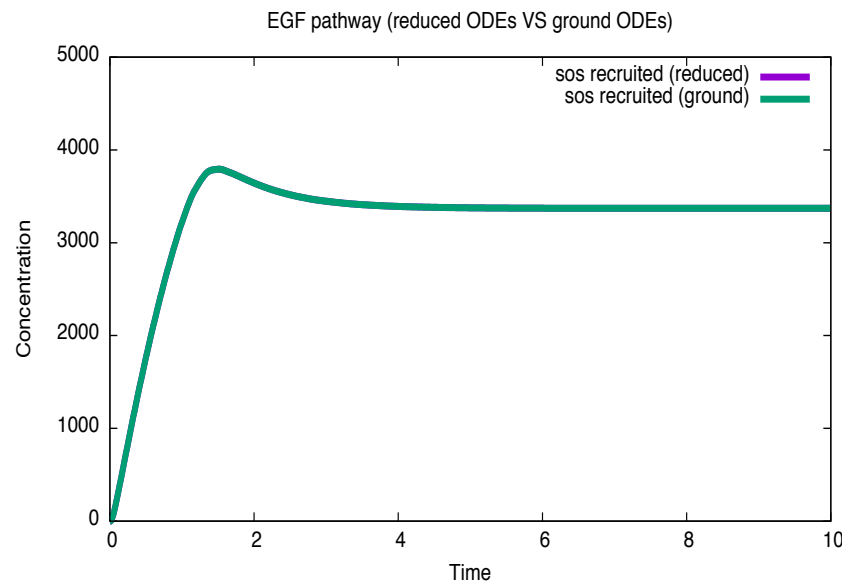

On a bigger model, 10^{19} chemical species are reduced into 180 000 fragments. [PNAS'09,LICS'10,Chaos'10]